

NAME	RINGO 1535 SURFACE MOUNTED CI		
REFERENCE	299025 - 180° LEDLINE 2700K - ANODIC BROWN	TYPE A	
	299026 - 180° LEDLINE 2700K - TEXT. BLACK	TYPE A	
	299027 - 180° LEDLINE 2700K - TEXT. WHITE	TYPE A	
	299035 - 180° LEDLINE 3000K - ANODIC BROWN	TYPE A	
	299036 - 180° LEDLINE 3000K - TEXT. BLACK	TYPE A	
	299037 - 180° LEDLINE 3000K - TEXT. WHITE	TYPE A	
	299045 - 180° LEDLINE 4000K - ANODIC BROWN	TYPE A	
	299046 - 180° LEDLINE 4000K - TEXT. BLACK	TYPE A	
	299047 - 180° LEDLINE 4000K - TEXT. WHITE	TYPE A	
	299125 - 90° LEDLINE 2700K + 90° 3xM10 - ANODIC BROWN	TYPE B	
	299126 - 90° LEDLINE 2700K + 90° 3xM10 - TEXT. BLACK	TYPE B	
	299127 - 90° LEDLINE 2700K + 90° 3xM10 - TEXT. WHITE	TYPE B	
	299135 - 90° LEDLINE 3000K + 90° 3xM10 - ANODIC BROWN	TYPE B	
	299136 - 90° LEDLINE 3000K + 90° 3xM10 - TEXT. BLACK	TYPE B	
	299137 - 90° LEDLINE 3000K + 90° 3xM10 - TEXT. WHITE	TYPE B	
	299145 - 90° LEDLINE 4000K + 90° 3xM10 - ANODIC BROWN	TYPE B	
	299146 - 90° LEDLINE 4000K + 90° 3xM10 - TEXT. BLACK	TYPE B	
	299147 - 90° LEDLINE 4000K + 90° 3xM10 - TEXT. WHITE	TYPE B	
	299225 - 180° 6xM10 - ANODIC BROWN	TYPE C	
	299226 - 180° 6xM10 - TEXT. BLACK	TYPE C	
299227 - 180° 6xM10 - TEXT. WHITE	TYPE C		
299425 - 180° EMPTY - ANODIC BROWN	TYPE D		
299426 - 180° EMPTY - TEXT. BLACK	TYPE D		
299427 - 180° EMPTY - TEXT. WHITE	TYPE D		
299525 - 90° EMPTY + 90° 3xM10 - ANODIC BROWN	TYPE E		
299526 - 90° EMPTY + 90° 3xM10 - TEXT. BLACK	TYPE E		
299527 - 90° EMPTY + 90° 3xM10 - TEXT. WHITE	TYPE E		
299615 - 90° LEDLINE 2700K + 90° EMPTY - ANODIC BROWN	TYPE F		
299616 - 90° LEDLINE 2700K + 90° EMPTY - TEXT. BLACK	TYPE F		
299617 - 90° LEDLINE 2700K + 90° EMPTY - TEXT. WHITE	TYPE F		
299635 - 90° LEDLINE 3000K + 90° EMPTY - ANODIC BROWN	TYPE F		
299636 - 90° LEDLINE 3000K + 90° EMPTY - TEXT. BLACK	TYPE F		
299637 - 90° LEDLINE 3000K + 90° EMPTY - TEXT. WHITE	TYPE F		
299645 - 90° LEDLINE 4000K + 90° EMPTY - ANODIC BROWN	TYPE F		
299646 - 90° LEDLINE 4000K + 90° EMPTY - TEXT. BLACK	TYPE F		
299647 - 90° LEDLINE 4000K + 90° EMPTY - TEXT. WHITE	TYPE F		

SPECIFICATIONS	Value
Lamptype	ledline = curved led array, spot = Luxeon M or BR.LUX (LES 9)
Symbol	
CCT	2700K - 3000K - 4000K / spot (see manual)
Luminous flux	ledline = 5200lm per 180° (A), per spot = see manual
Power	ledline = 48W per 180° (A), per spot = see manual
Voltage	230V 50-60Hz AC
CRI	ledline = 80, spot = 90
SDCM	3
Beamangle	ledline = lambertian, spot = 36°
Orientability	only for spot = 359° rotating & 90° tilting
Gear	converter incorporated in base
Dimmability	depending on base
Safe distance to object	0,1m
Class / IP	IP20
Application	interior - surface mounted

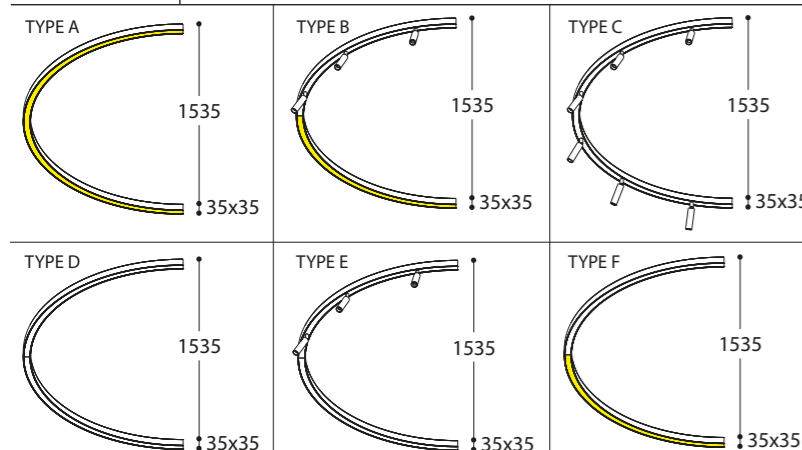

INSTALLATION

1. MOUNT BRACKETS TO CEILING VIA DRILL PATTERN, KEEP ELECTRICAL FEED POINT IN MIND
 .MAKE PRIMARY ELECTRICAL CONNECTION IN CONNECTOR A (3p or 5p for 1-10V dimm)
 (see wiring schemes on next page & LEAVE UNSWITCHED)

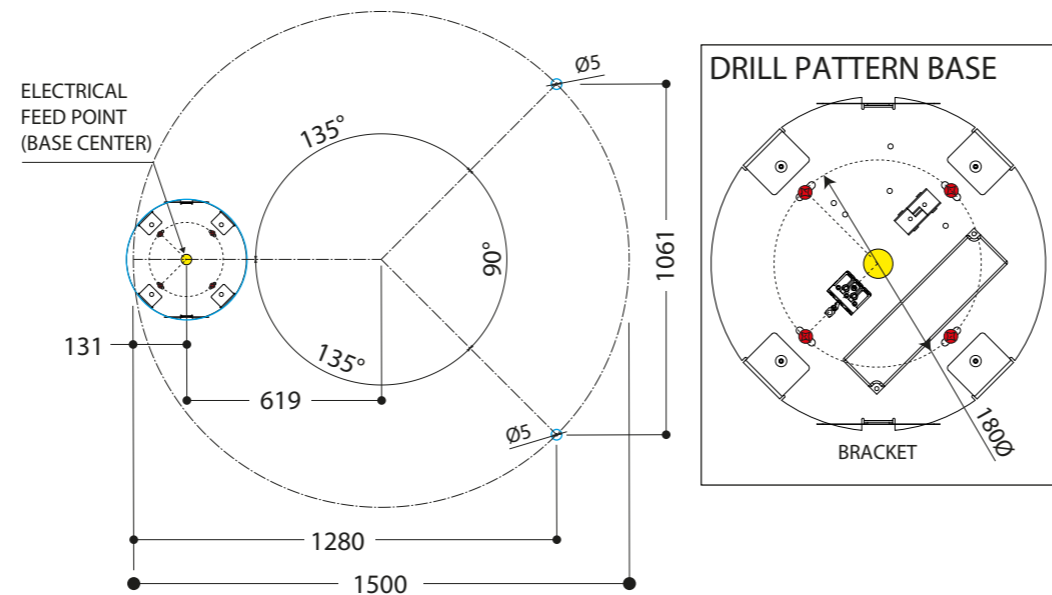

- ⚠ ALWAYS KEEP CEILING BRACKET ORIENTATION IN MIND
- ⚠ IT IS ALSO POSSIBLE TO MAKE THE DRILL PATTERN OVER 120°

3. PUSH CEILING HOUSING GENTLY ONTO THE CEILING BRACKET UNTIL IT SNAPS OVER THE 2 LEAF SPRINGS, APPLY LITTLE TWIST UNTIL CEILING HOUSING IS FITTED PROPERLY AGAINST CEILING. PLEASE GUIDE THE SECONDARY WIRES SO THEY DO NOT CLAMP BETWEEN THE HOUSING AND THE LEAF SPRINGS.

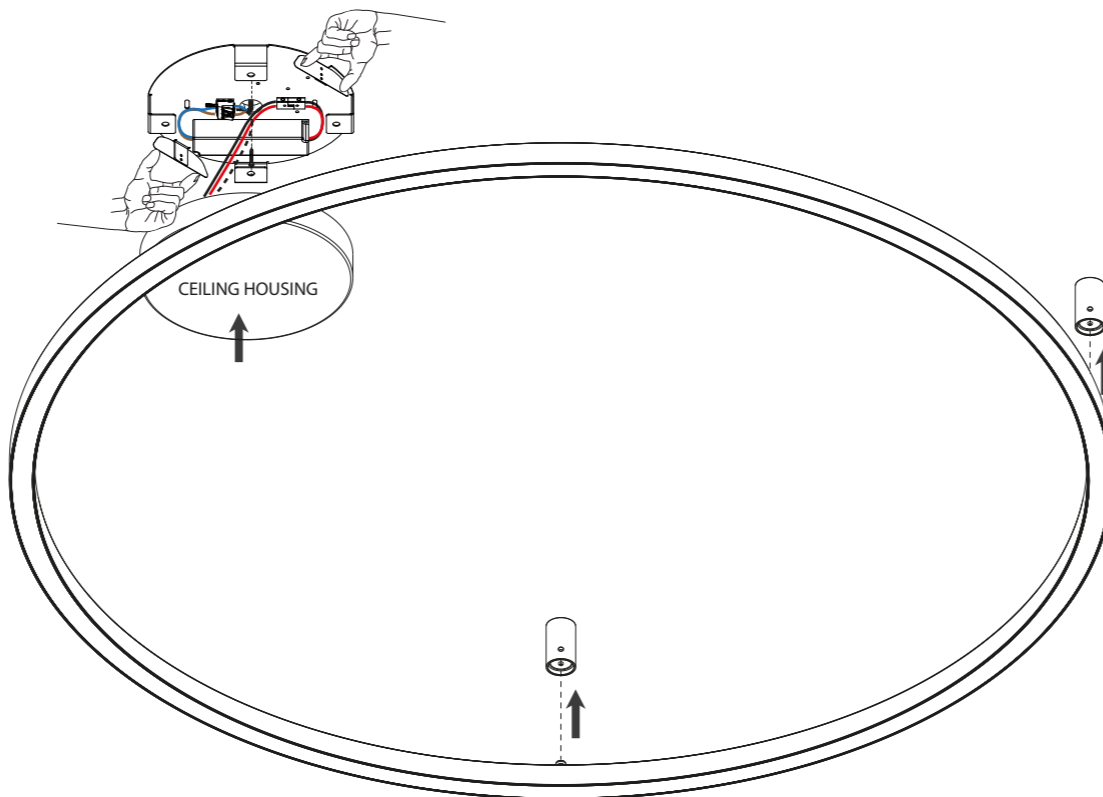

- ⚠ IMPOSSIBLE COMBINATIONS:
 - TYPE C + C - TYPE D + D - TYPE C + E - TYPE D + F

- ⚠ ALWAYS DISCONNECT MAINS POWER SUPPLY FROM CONVERTER BEFORE SWITCHING "ON" LED LUMINAIRES TO PREVENT HOT PLUGGING ISSUES!

NL Installatie- en onderhoudsrichtlijnen m.b.t. de fabrieksgarantie.
 1. De plaatsing, de aansluiting en het uittesten van dit toestel dient steeds te gebeuren door een erkend elektro-installeur.
 2. Dit toestel moet geïnstalleerd, verbonden en getest worden volgens de nationaal geldende reglementen op elektrische installaties.
 3. De technische bijsluitert dient te worden beschouwd als een onderdeel van de algemene verkoopvoorwaarden van TAL nv.
 4. De elektro-installeur is verantwoordelijk voor het gebruik van compatibele voorschakelapparatuur die voldoen aan de geldende IEC normen.
 5. Reinig het toestel enkel met een zachte en lichtvochtige doek zonder reinigingsmiddel.
 6. Schakel altijd eerst de elektriciteit uit alvorens het toestel te plaatsen en te installeren.

EN Installation and maintenance instructions regarding the manufacturer's warranty.
 1. Installation, connection and testing of this product must always be performed by a certified electrician.
 2. This product must be installed, connected and tested in accordance with the applicable national regulations for electrical installations.
 3. The technical manual must be regarded as part of the general sales conditions of TAL nv.
 4. The electrical installer is responsible for the use of compatible control gear that meets the applicable IEC standards.
 5. Only clean the device with a soft and slightly moist cloth without detergent.
 6. Always switch off the electricity supply before installing and connecting the product.

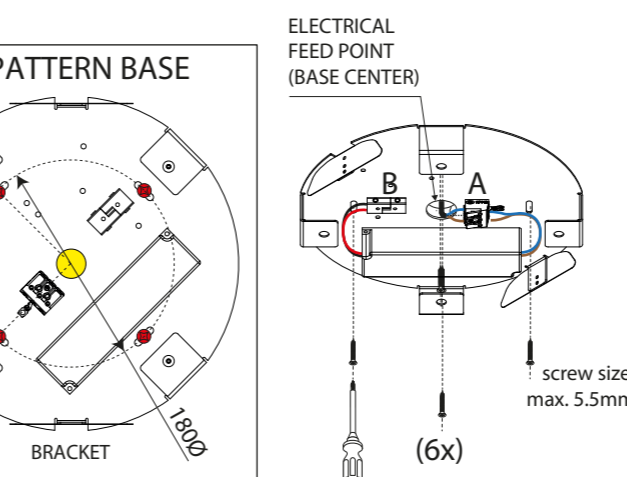

2. MAKE SECONDARY ELECTRICAL CONNECTION(S) IN CONNECTOR(S) B
 .MAKE EARTHING CONNECTION FROM HOUSING IN CONNECTOR A
 (see wiring schemes on next page)

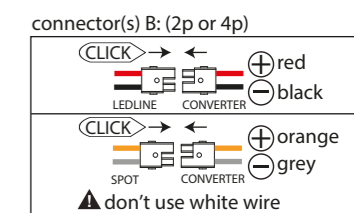
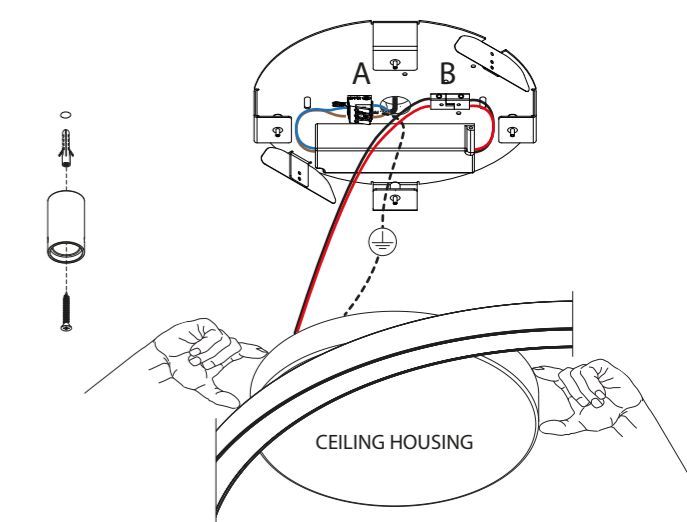

4. FIX THE CEILING BRACKETS AND SWITCH ON MAINS POWER SUPPLY

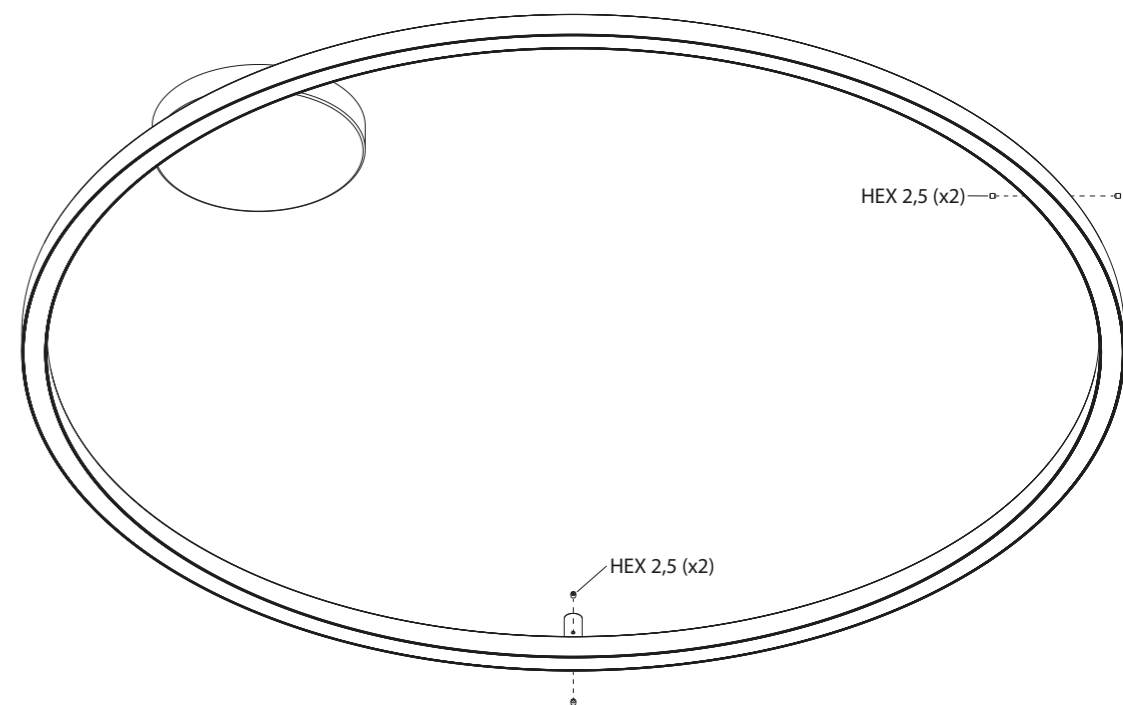

⚠ SEE NEXT PAGE FOR BASE WIRING SCHEMES

ACCESSORY		optional (U)
NAME	ACCESSORY NAME	
REFERENCE	892630	EXTRA CIRCUIT /m COMMON NEUTRAL
	892631	EXTRA CIRCUIT /m NO COMMON NEUTRAL
	892632	EXTRA CIRCUIT /m FOR DIMMING SIGNAL

DE Installations- und Wartungsanweisungen bezüglich der Herstellergarantie.
 1. Installation, Anschluß und Prüfung dieses Geräts soll nur von einem anerkannten Elektriker ausgeführt werden.
 2. Dieses Gerät soll in Übereinstimmung mit den nationalen geltenden Vorschriften für Elektroinstallationen installiert, angeschlossen und geprüft werden.
 3. Die technische Anleitung muß als Teil der allgemeinen Verkaufsbedingungen von TAL nv betrachtet werden.
 4. Der Elektroinstallateur ist verantwortlich für die Verwendung von kompatiblen Betriebsgeräten, die den geltenden IEC-Normen entsprechen.
 5. Reinigen Sie das Gerät nur mit einem weichen und leicht feuchten Tuch ohne Reinigungsmittel.
 6. Schalten Sie den Strom immer aus, bevor Sie das Gerät installieren und anschließen.

FR Instructions d'installation et d'entretien concernant la garantie du fabricant.
 1. L'installation, la connexion et les essais de cet appareil doivent toujours être effectués par un électricien reconnu.
 2. Cet appareil doit être installé, raccordé et testé conformément aux réglementations nationales pour les installations électriques.
 3. La notice technique doit être considérée comme faisant partie des conditions générales de vente de TAL SA.
 4. L'installateur électrique est responsable de l'utilisation d'un équipement de contrôle compatible qui satisfait aux normes CEI applicables.
 5. Nettoyez l'appareil uniquement avec un chiffon doux et légèrement humide sans détergent.
 6. Éteignez toujours l'électricité avant d'installer et de connecter l'appareil.

⚠ **RECOMMENDED NUMBER OF INSTALLERS:**

6 POSSIBLE WIRING SCHEMES FOR RINGO 1185 BASES:

28980X / 29980X
Ringo Base Ledline

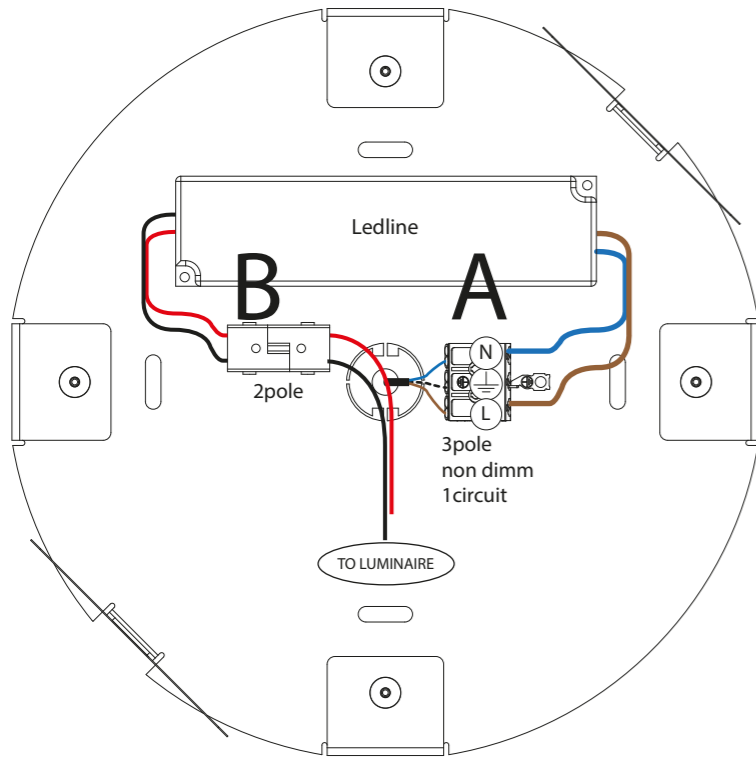

28981X / 29981X / 28982X / 29982X
Ringo Base Ledline + Spot

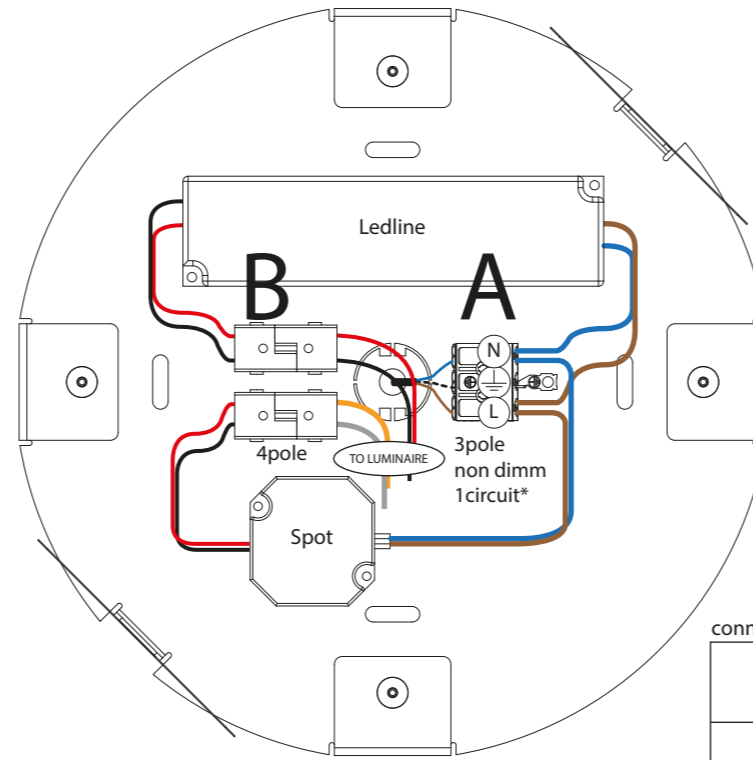

28986X / 29986X
Ringo Base Spot

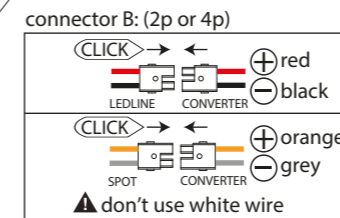
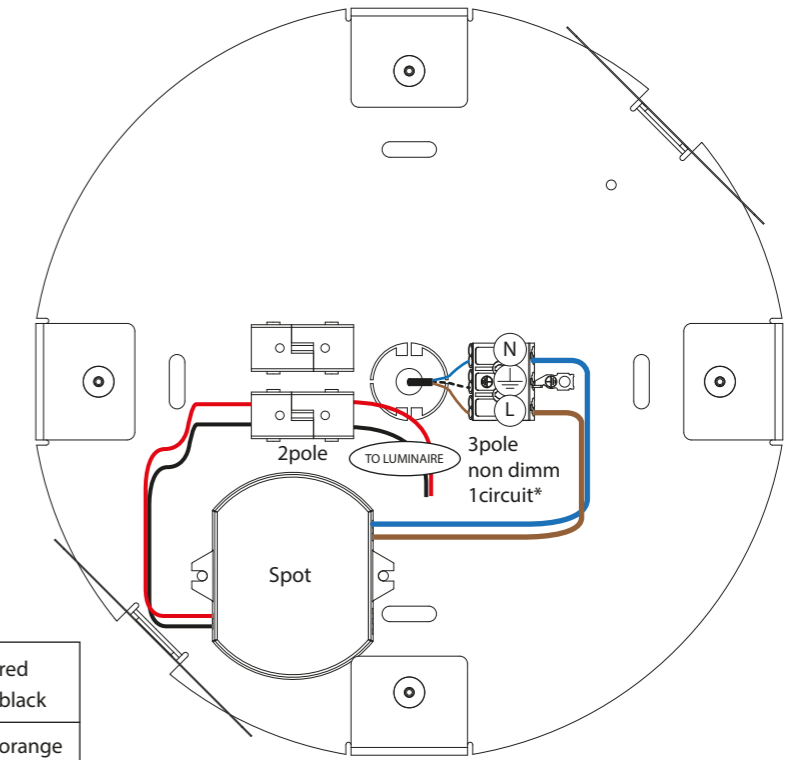

28983X / 29983X
Ringo Base Ledline 1-10V DIMM

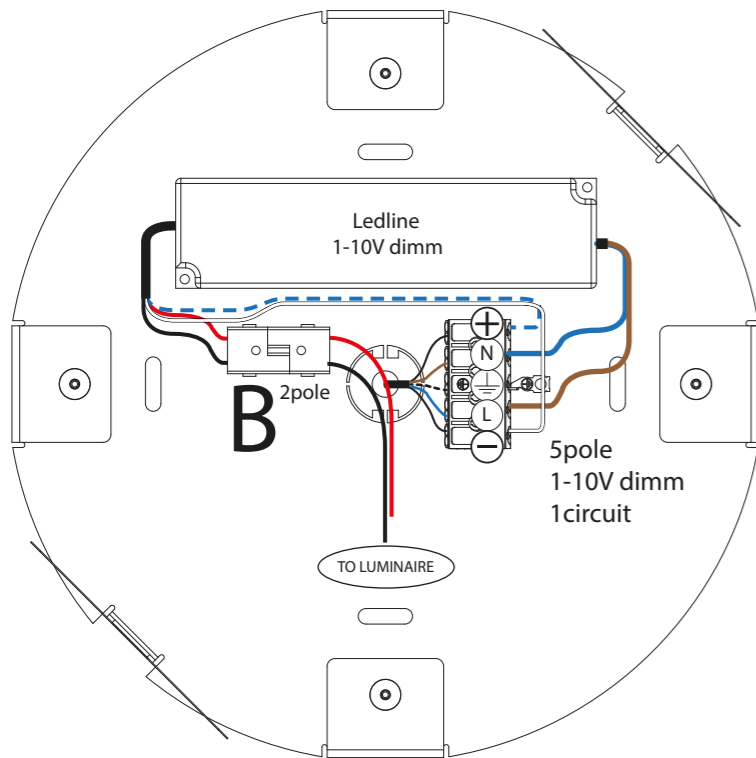

28984X / 29984X / 28985X / 29985X
Ringo Base Ledline + Spot 1-10V DIMM

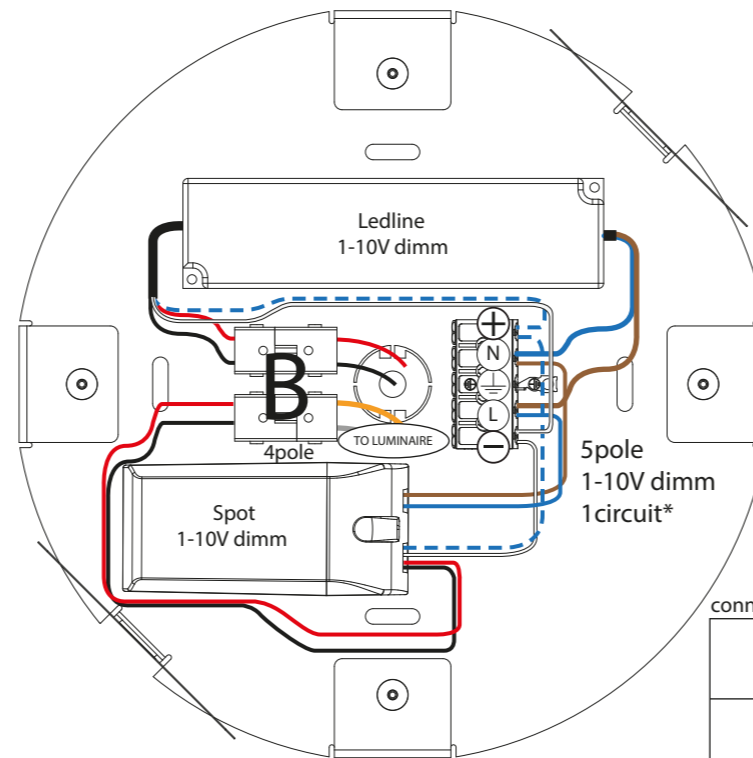

28987X / 29987X
Ringo Base Spot 1-10V DIMM

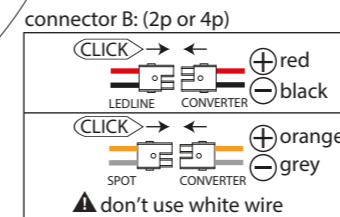
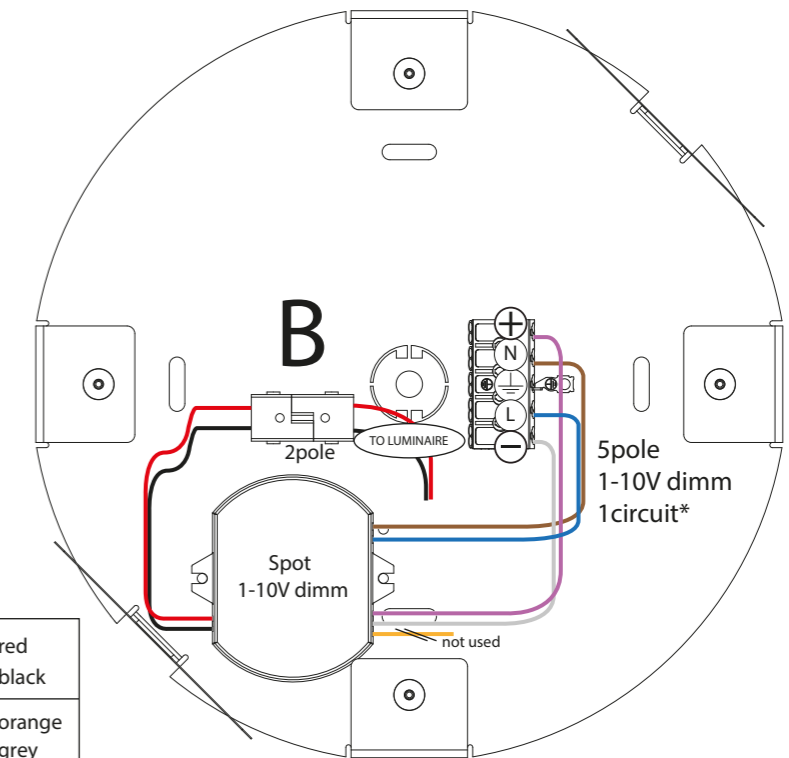

 *extra primary circuit is possible on request

 *extra primary circuit is possible on request

